



US00D822986S

(12) **United States Design Patent**  
**Viger et al.**

(10) **Patent No.:** **US D822,986 S**

(45) **Date of Patent:** **\*\* Jul. 17, 2018**

(54) **MESSENGER BAG**

(71) Applicant: **Peak Design**, San Francisco, CA (US)

(72) Inventors: **Arthur Viger**, San Francisco, CA (US);  
**Peter Dering**, San Francisco, CA (US);  
**Robb Jankura**, San Francisco, CA  
(US); **Joseph Cunningham**, San  
Francisco, CA (US); **Peter Lockett**, San  
Francisco, CA (US)

(73) Assignee: **Peak Design**, San Francisco, CA (US)

(\*\*) Term: **15 Years**

(21) Appl. No.: **29/569,596**

(22) Filed: **Jun. 29, 2016**

(51) **LOC (11) Cl.** ..... **03-01**

(52) **U.S. Cl.**  
USPC ..... **D3/246**

(58) **Field of Classification Search**  
USPC ..... D3/232–233, 240–243, 245–246  
CPC ..... A45C 1/024; A45C 3/06  
See application file for complete search history.

(56) **References Cited**

**U.S. PATENT DOCUMENTS**

6,206,567 B1 3/2001 Cyr  
D520,747 S \* 5/2006 McClain ..... D3/290  
D651,794 S \* 1/2012 Hargens ..... D3/232

D722,228 S \* 2/2015 Zwetzig ..... D3/232  
D742,634 S \* 11/2015 Zwetzig ..... D3/232  
D758,719 S \* 6/2016 Harper ..... D3/232

\* cited by examiner

*Primary Examiner* — Holly H Baynham  
(74) *Attorney, Agent, or Firm* — Grumbles Law PLLC;  
Brittany Nanzig; Paul Feng

(57) **CLAIM**

The ornamental design for a messenger bag, as shown and described.

**DESCRIPTION**

FIG. 1 is a perspective front view of a messenger bag showing our new design.

FIG. 2 is a perspective back view of the messenger bag.

FIG. 3 is a front elevational view of the messenger bag.

FIG. 4 is a back elevational view of the messenger bag.

FIG. 5 is a top elevational view of the messenger bag.

FIG. 6 is a bottom elevational view of the messenger bag.

FIG. 7 is a left side elevational view of the messenger bag.

FIG. 8 is a right side elevational view of the messenger bag.

FIG. 9 is a front elevational view of the messenger bag in an open position; and,

FIG. 10 is a back elevational view of the messenger bag in an open position.

The lighter broken lines depict stitching and are part of the claimed design. The bold broken lines showing the zipper pull are for the purposes of illustrating environment and form no part of the claimed design.

**1 Claim, 7 Drawing Sheets**

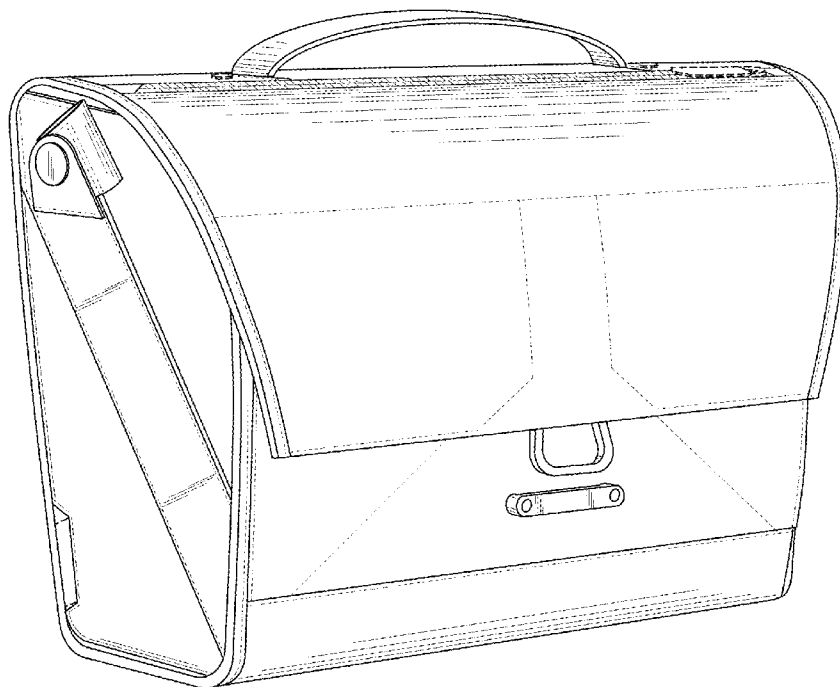



FIG. 1

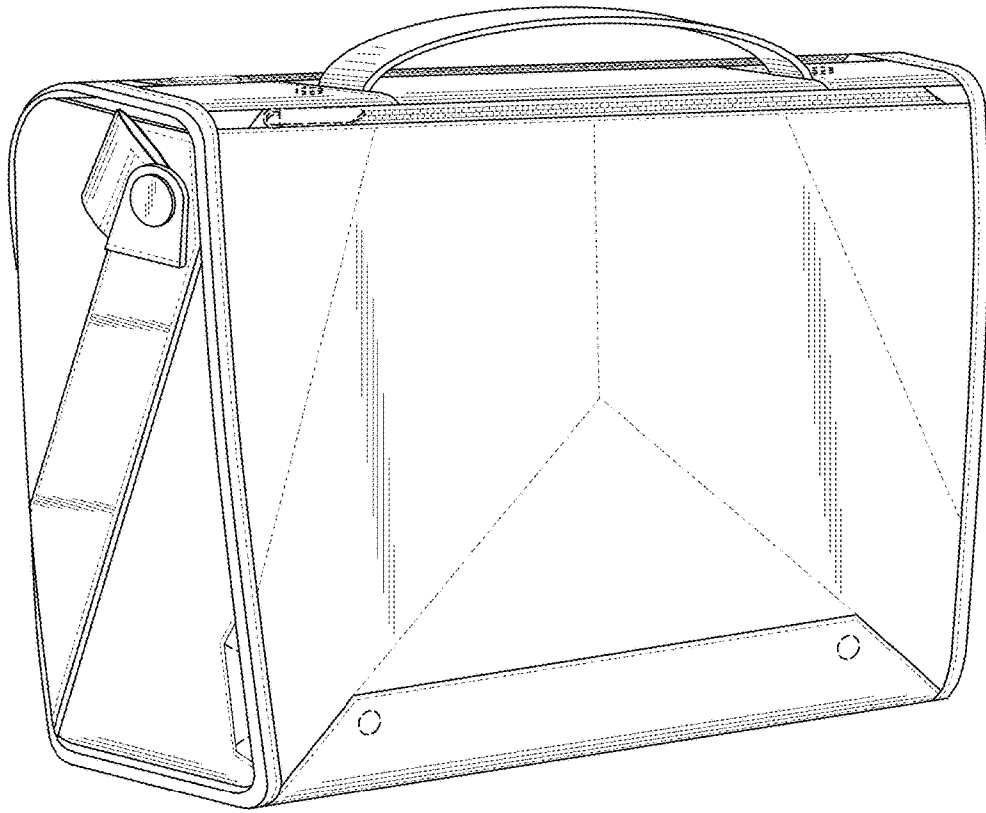

FIG. 2

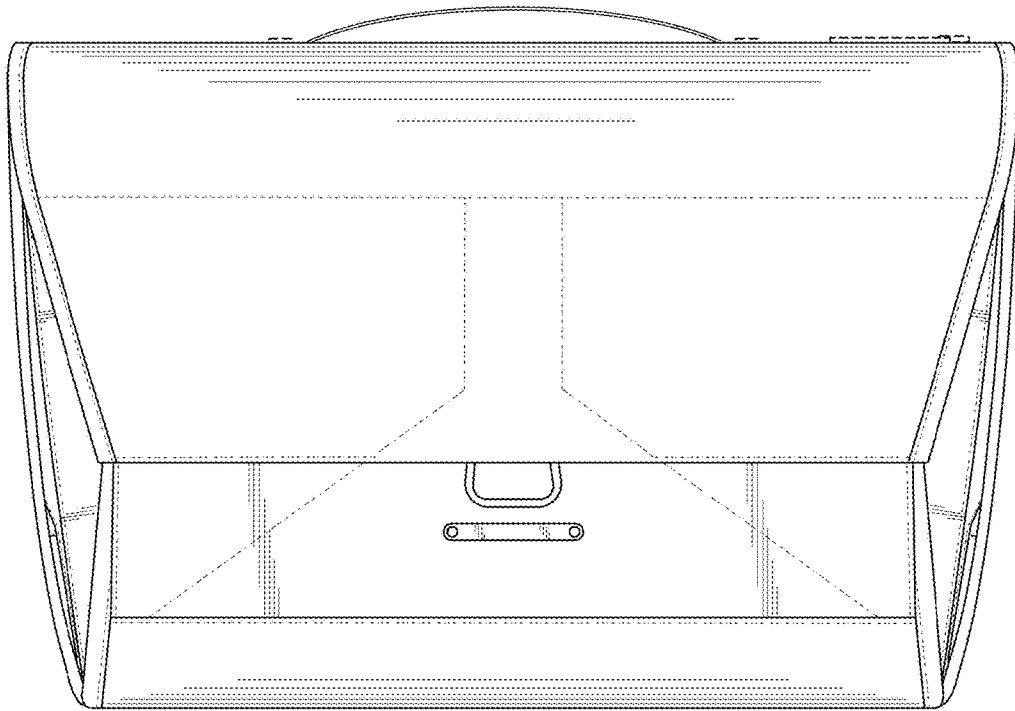

FIG. 3

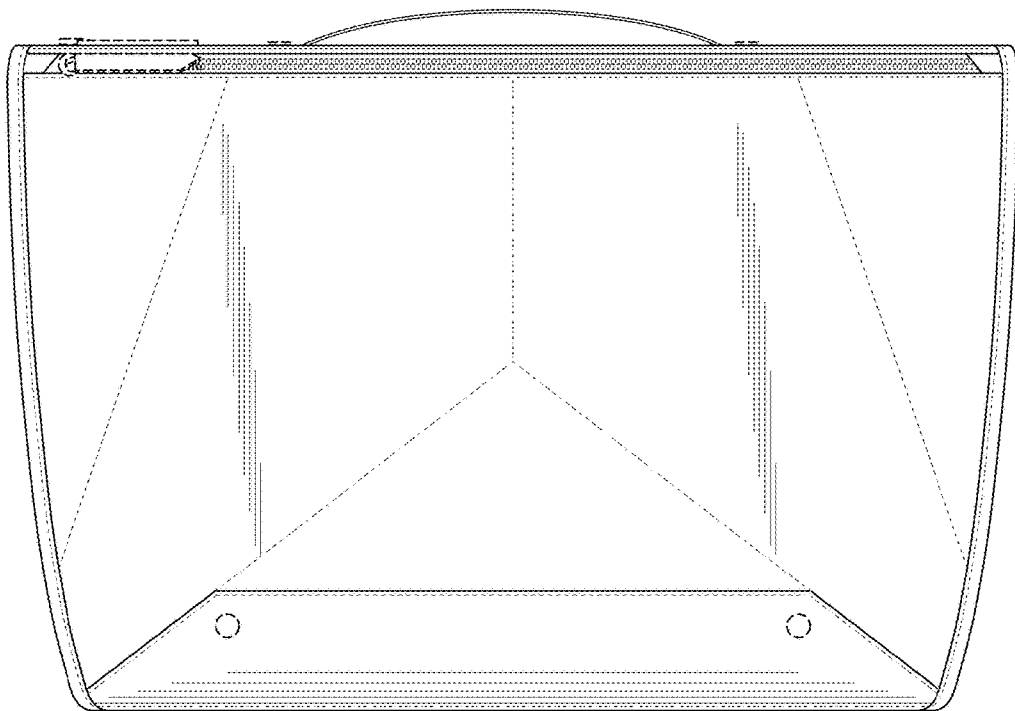

FIG. 4

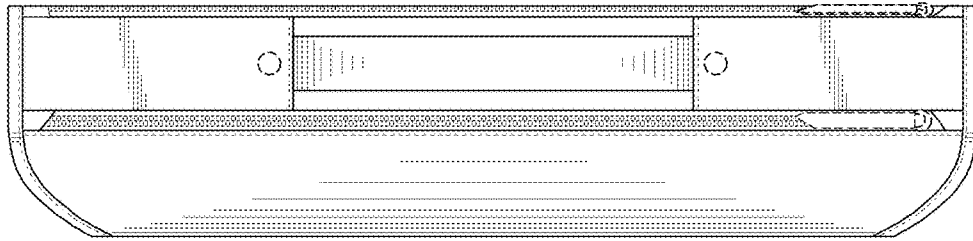

FIG. 5

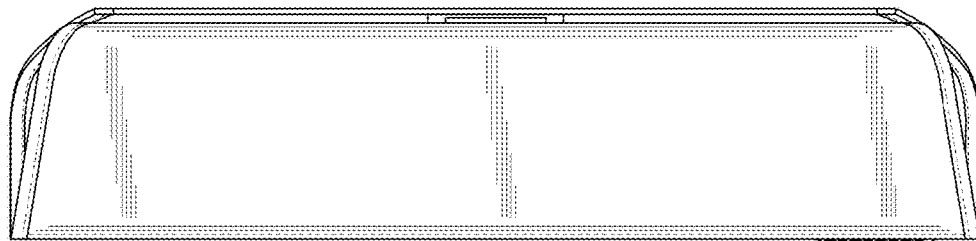

FIG. 6

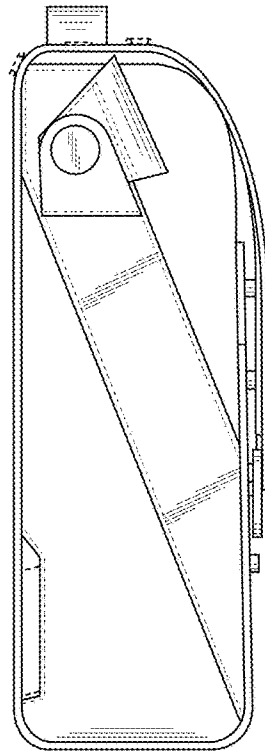

FIG. 7

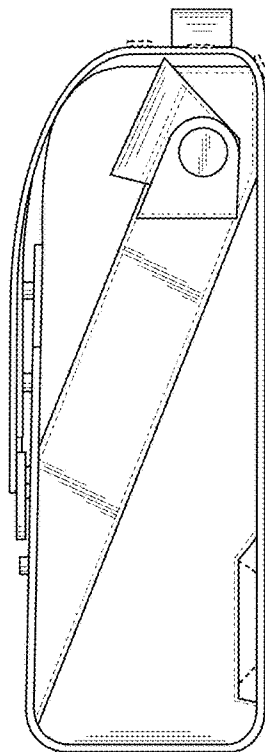

FIG. 8

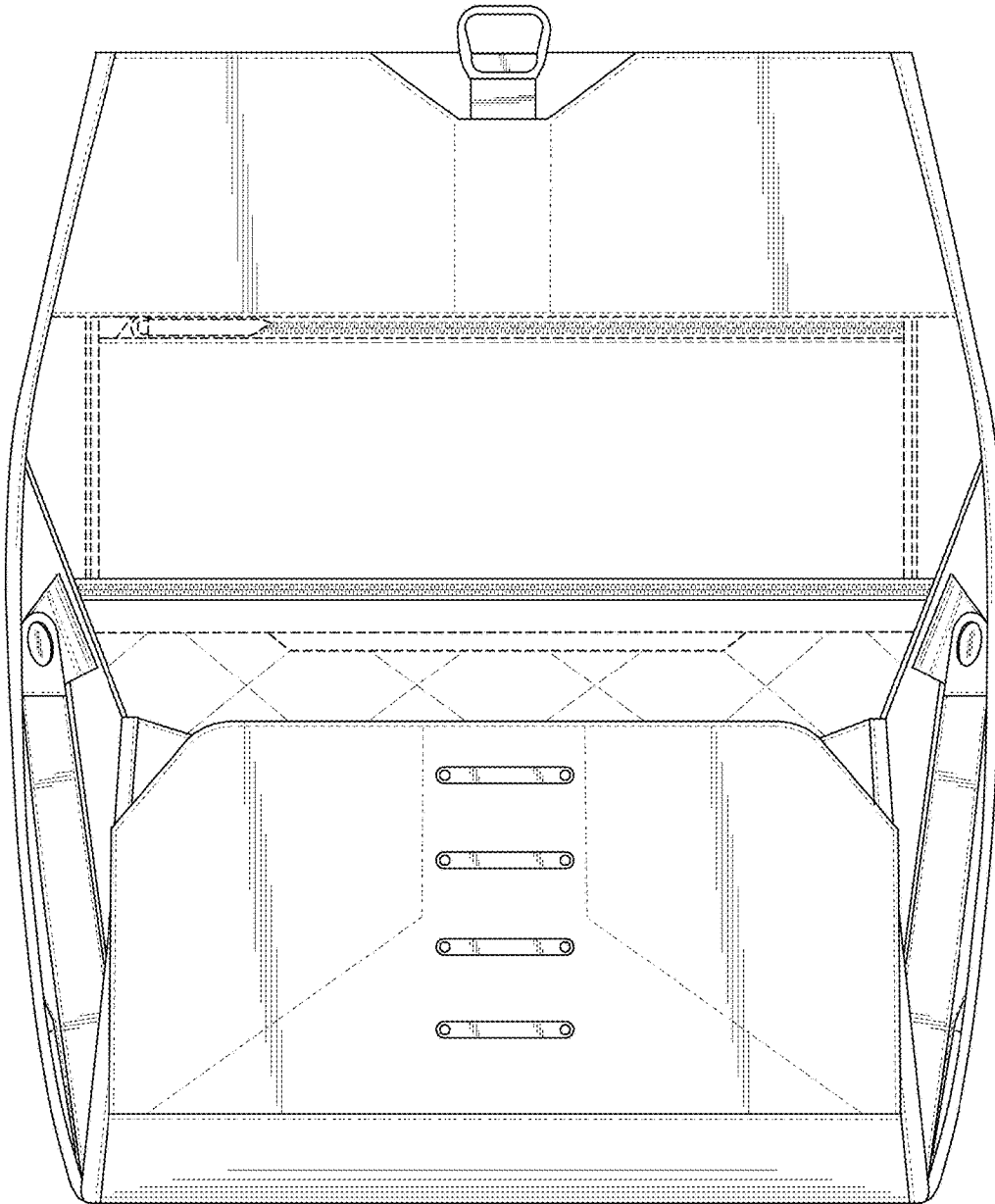

FIG. 9

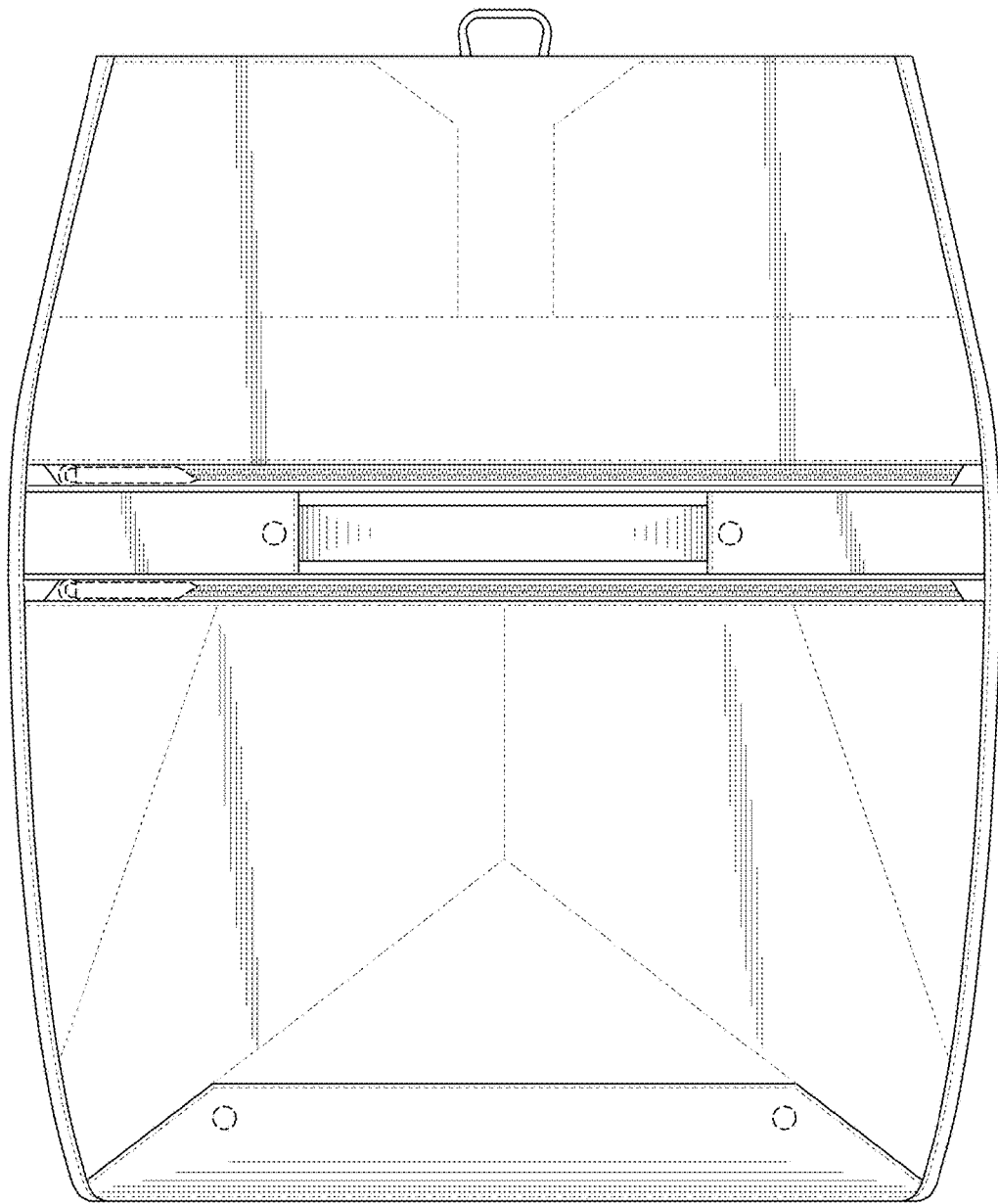

FIG. 10